

DESCRIPTION

The classic W40 range is an evolution of the famous W20 range developed in 1964. Produced for the first time in 1995 it consists of 18 profiles and follows the unmistakable classic design of its predecessor. The strong point of this “young” series, is the increased profile depth, which allows to accommodate double glazing up to a thickness of 27mm. The W40 suite is not only used in the field of restoration, but it’s also highly acclaimed in contemporary architecture for its elegant and compact sightlines, ensuring safety and comfort thanks to its excellent thermal and acoustic performance. Despite the depth of this system is only of 42 respectively 47 mm, technically it is considered a “heavy duty” range, which allows making large windows thanks to the extraordinary strength of steel.

Any kind of inward or outward openings: side-hung, double-vent (French style), bottom-hung, top-hung or projected top-hung, horizontally and vertically pivoted windows, as well as large sliding and folding doors.

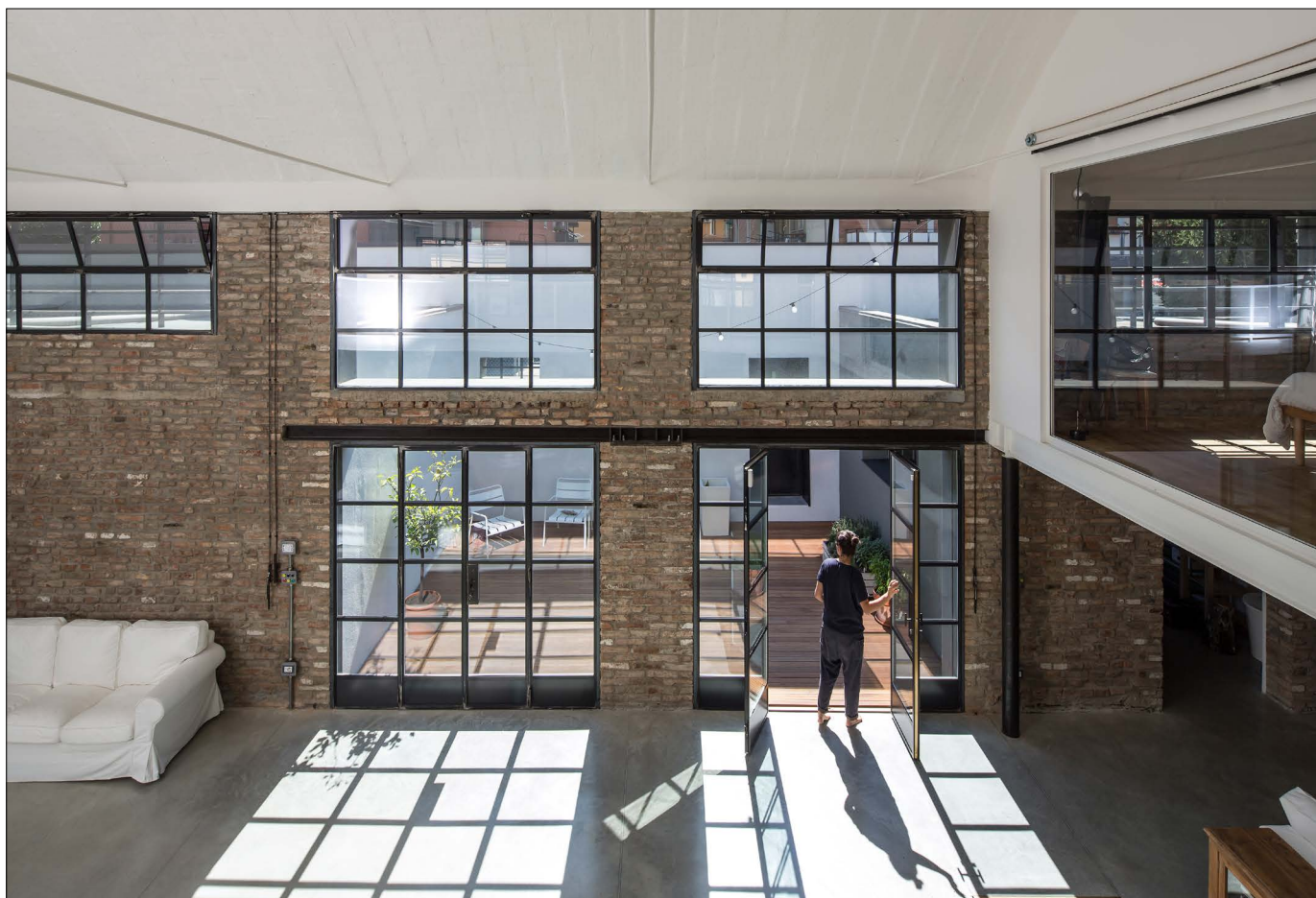

TECHNICAL DATA

1. Solid hot rolled profiles.
2. "Stepped leg" design.
3. Material thickness up to 5 mm.
4. Very compact profiles with minimal depth and sightlines.
5. Self-adhesive non-shrinking gaskets.
6. Low emissivity double-glazing up to 27 mm.
7. Choice of different glazing beads.
8. Appropriate for heavy-duty corrosion protection.

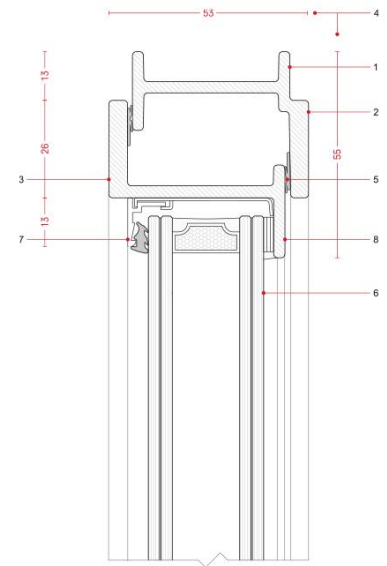

GLAZING

All our Classic W40 windows are internally beaded for enhanced security

All windows have 27mm double glazed unit with a U-value 1,0W/m²K and in standard comes with low emission coating

Within required by Building Regulation areas included is safety glazing





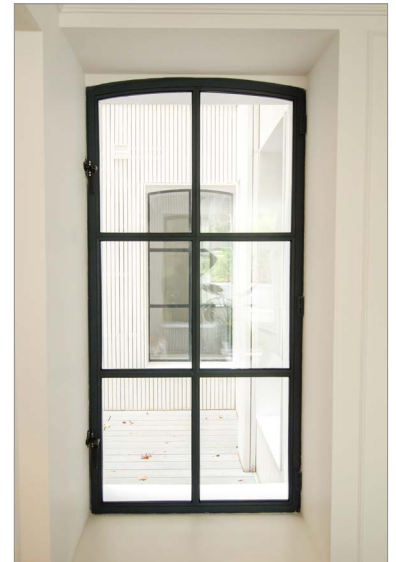

We also offer additionally ranges of coloured, toughened, laminated glass for extra security. Some other available glass options:

Tripleglazed units for sound reduction and energy efficiency

- Acoustic
- Solar control
- Self cleaning
- Digital print units
- Ornamental



TEST CENTRE

Norm	Test			
		Inward opening	Outward opening	Inward opening
EN12208 	Watertightness	up to Class 9A - 600 Pa	up to Class 9A - 600 Pa	up to Class 6A/7B - 300 Pa
EN12210 	Resistance to wind load	up to Class C5 - 2000 Pa	up to Class C5 - 2000 Pa	up to Class C3 - 1200 Pa
EN12207 	Air permeability	up to Class C4 - 600 Pa	up to Class C4 - 600 Pa	up to Class C4 - 600 Pa
EN10077-1 	Heat transfer coefficient	from > 1,90 W/m²K	from > 1,90 W/m²K	from > 1,90 W/m²K



YORD Ltd
10 Island Centre Way
Enfield Island Village
Enfield, EN3 6GS

tel: 0203 150 2041
email: enquiries@yord.co.uk
web: www.yord.co.uk